

Pushbutton Switches/Pilot Lights

A16/M16

Mounting Aperture of 16 mm

- Modular construction (Pushbutton + Case + Lamp + Switch Unit)
- “Snap-in” switch unit for quick and easy, tool-free assembly
- Wide range of switching capacity from general to microload
- High reliability IP65 or IP40 models
- Short mounting depth, less than 28.5 mm below panel
- Terminal layout simplifies common wiring
- UL and CSA approved, VDE (pending)
- Conforms to EN60943-5-1, IEC947-5-1



Ordering Information

■ CONSTRUCTION

Flange Shape

- Rectangular (A16□-J)
- Square (A16□-A)
- Round (A16□-T)

Available Colors

- For LED/incandescent
Red, green, yellow, white, blue
 - For non-illuminated
Red, green, yellow, white, blue, black
- (Actual color of yellow pushbuttons more closely resembles amber than true yellow.)

Protective Case and Terminal Type

- **Protective Structure**
IP40/Oil-resistant IP65
- **Terminal Type**
Solder terminals
(tab terminals #110)

Lamp

- LED
- Incandescent lamp

Switch Unit Specifications

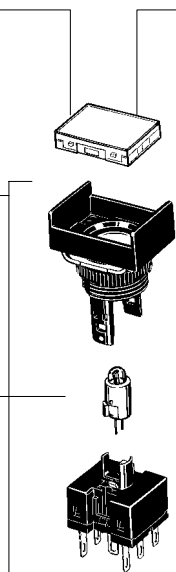

- **Ratings**
125 VAC: 5 A
250 VAC: 3 A
30 VDC 3 A
Minimum applicable load: 1 mA at 5 VDC

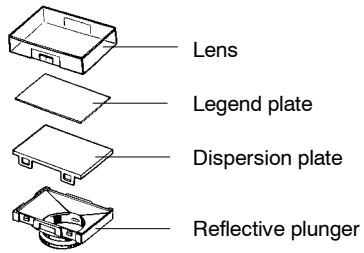

Structure of Pushbutton

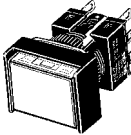
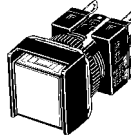

MODELS

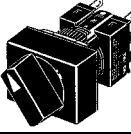
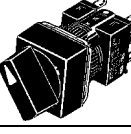
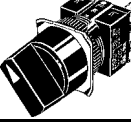
Item	Shape		Part number
Pushbutton Switches	Rectangular		A16-J A165-J
	Square		A16-A A165-A
	Round		A16-T A165-T
Knob-type Selector Switches	Rectangular		A165S-J (Non-illuminated) A165W-J (Illuminated)
	Square		A165S-A (Non-illuminated) A165W-A (Illuminated)
	Round		A165S-T (Non-illuminated) A165W-T (Illuminated)

Item	Shape		Part number
Key-type Selector Switches	Rectangular		A165K-J
	Square		A165K-A
	Round		A165K-T
Pilot Lights	Rectangular		M16-J M165-J
	Square		M16-A M165-A
	Round		M16-T M165-T
Emergency Stop Switches			A165E
Buzzers			M2BJ-B M2BJ-BH

■ PART NUMBER LEGEND A16 NON-ILLUMINATED PUSHBUTTONS (COMPLETE ASSEMBLY)

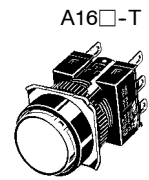
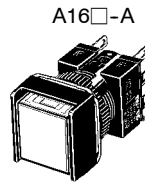
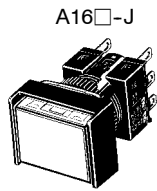

A16 Part number nomenclature

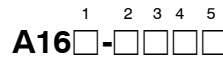

1 Enclosure Rating

Code	Description
None	IP40
5	IP65 oil-resistant

4 Operating Function

Code	Description
M	Momentary
A	Alternate action

2 Shape

Code	Shape	Description
T	Round	Extended
A	Square	2 directions, guarded
J	Rectangular	2 directions, guarded

5 Contact form and terminal type

Code	Contact form	Terminal
1	1C SPDT (See Note)	Solder terminal
2	2C DPDT (See Note)	Solder terminal

Note: SPDT: Single Pole, Double Throw
DPDT: Double Pole, Double Throw

3 Operator Color

Code	Description
R	Red
Y	Yellow
G	Green
W	White
A	Blue
B	Black (for non-illuminated only)

(Actual color of yellow pushbuttons more closely resembles amber than true yellow.)

■ PART NUMBERS: NON-ILLUMINATED PUSHBUTTON SWITCHES (COMPLETE ASSEMBLY)

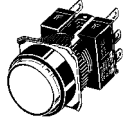
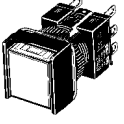
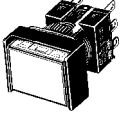
Description	Shape	Contact	Part number			
			Momentary		Alternate action (See Note 2.)	
			Enclosed (IP40)	Oiltight (IP65)	Enclosed (IP40)	Oiltight (IP65)
Non-Illuminated Standard Button	Round 	SPDT	A16-T□M-1	A165-T□M-1	A16-T□A-1	A165-T□A-1
		DPDT	A16-T□M-2	A165-T□M-2	A16-T□A-2	A165-T□A-2
	Square 	SPDT	A16-A□M-1	A165-A□M-1	A16-A□A-1	A165-A□A-1
		DPDT	A16-A□M-2	A165-A□M-2	A16-A□A-2	A165-A□A-2
	Rectangular 	SPDT	A16-J□M-1	A165-J□M-1	A16-J□A-1	A165-J□A-1
		DPDT	A16-J□M-2	A165-J□M-2	A16-J□A-2	A165-J□A-2

Note: 1. To complete the part number, in place of the □ symbol, specify the color code from the table below.
 2. Also described as Push-on / Push-off operation.

Operator Color Codes

(Actual color of yellow pushbuttons more closely resembles amber than true yellow.)

Code	Color
R	Red
Y	Yellow
G	Green
W	White
A	Blue
B	Black

Note: Also described as Push-on/Push-off operation.

■ PART NUMBER LEGEND M16 ASSEMBLED PILOT LIGHTS

M16□-J



M16□-A

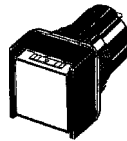

M16□-T

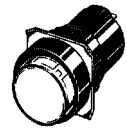

M16 Part number nomenclature

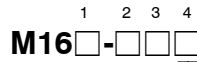

1 Enclosure Rating

Code	Description
None	IP40
5	IP65 oil-resistant

3 Operator Color

Code	Description
R	Red
Y	Yellow
G	Green
W	White
A	Blue

(Actual color of yellow pushbuttons more closely resembles amber than true yellow.)

2 Shape

Code	Shape	Description
T	Round	Extended
A	Square	2 directions, guarded
J	Rectangular	2 directions, guarded



4 Source of light

Code	Source	Voltage	
		Operating	Rated
5D	LED	DC5V	DC5V
12D	LED	DC12V	DC12V
24D	LED	DC24V	DC24V

Transformer

Code	Voltage	
	Operating	Rated
T1	AC100V	AC110V
T2	AC200V	AC220V

■ PART NUMBERS: PILOT LIGHTS (COMPLETE ASSEMBLY)

Style	Type	Voltage	Part number	
			IP40	IP65 Oiltight
Round 	Full voltage LED (DC)	5 VDC	M16-T□-5D	M165-T□-5D
		12 VDC	M16-T□-12D	M165-T□-12D
		24 VDC	M16-T□-24D	M165-T□-24D
	Transformer 24 V secondary	110 VAC	M16-T□-T1	M165-T□-T1
		220 VAC	M16-T□-T2	M165-T□-T2
Square 	Full voltage LED (DC)	5 VDC	M16-A□-5D	M165-A□-5D
		12 VDC	M16-A□-12D	M165-A□-12D
		24 VDC	M16-A□-24D	M165-A□-24D
	Transformer 24 V secondary	110 VAC	M16-A□-T1	M165-A□-T1
		220 VAC	M16-A□-T2	M165-A□-T2
Rectangular 	Full voltage LED (DC)	5 VDC	M16-J□-5D	M165-J□-5D
		12 VDC	M16-J□-12D	M165-J□-12D
		24 VDC	M16-J□-24D	M165-J□-24D
	Transformer 24 V secondary	110 VAC	M16-J□-T1	M165-J□-T1
		220 VAC	M16-J□-T2	M165-J□-T2

Note: To complete part number, in place of the □ symbol, specify the color code from the Lens Color Code table below.

Lens Color Codes

(Actual color of yellow lens more closely resembles amber than true yellow.)

Code	Color
R	Red
Y	Yellow
G	Green
W	White
A	Blue

■ PART NUMBER LEGEND A16 ILLUMINATED PUSHBUTTONS (COMPLETE ASSEMBLY)

Part Number Nomenclature

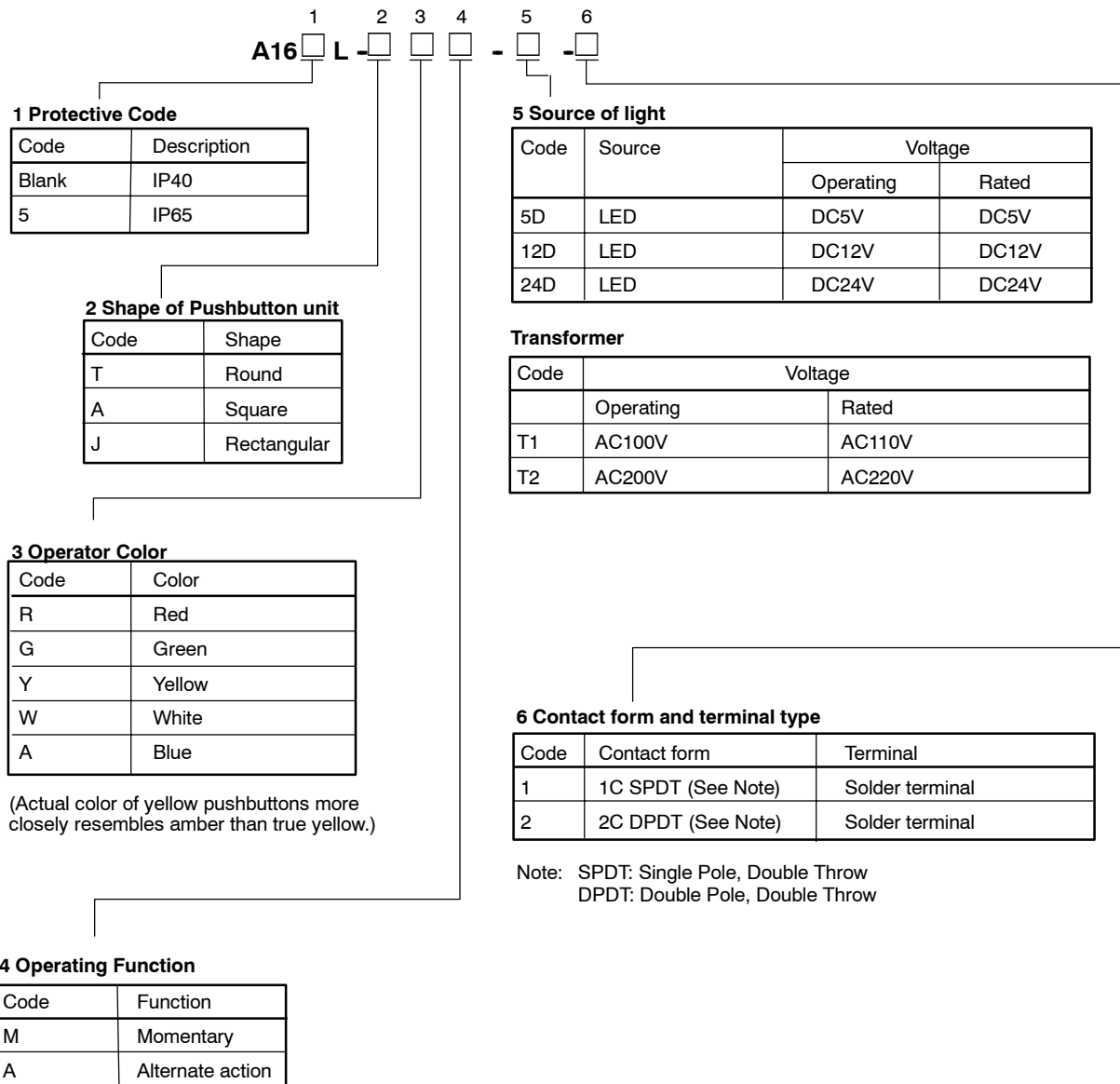

■ PART NUMBERS: A16 ILLUMINATED PUSHBUTTONS (COMPLETE ASSEMBLY)

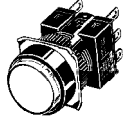
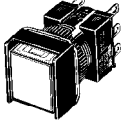
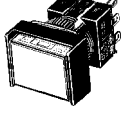
Style	Illumination method	Voltage	Contact	Part number			
				Momentary		Alternate action	
				Enclosed (IP40)	Oiltight (IP65)	Enclosed (IP40)	Oiltight (IP65)
	LED (DC)	5V	SPDT	A16L-T□M-5D-1	A165L-T□M-5D-1	A16L-T□A-5D-1	A165L-T□A-5D-1
		12V		A16L-T□M-12D-1	A165L-T□M-12D-1	A16L-T□A-12D-1	A165L-T□A-12D-1
		24V		A16L-T□M-24D-1	A165L-T□M-24D-1	A16L-T□A-24D-1	A165L-T□A-24D-1
	LED (DC)	5V	DPDT	A16L-T□M-5D-2	A165L-T□M-5D-2	A16L-T□A-5D-2	A165L-T□A-5D-2
		12V		A16L-T□M-12D-2	A165L-T□M-12D-2	A16L-T□A-12D-2	A165L-T□A-12D-2
		24V		A16L-T□M-24D-2	A165L-T□M-24D-2	A16L-T□A-24D-2	A165L-T□A-24D-2
	LED (DC)	5V	SPDT	A16L-A□M-5D-1	A165L-A□M-5D-1	A16L-A□A-5D-1	A165L-A□A-5D-1
		12V		A16L-A□M-12D-1	A165L-A□M-12D-1	A16L-A□A-12D-1	A165L-A□A-12D-1
		24V		A16L-A□M-24D-1	A165L-A□M-24D-1	A16L-A□A-24D-1	A165L-A□A-24D-1
	LED (DC)	5V	DPDT	A16L-A□M-5D-2	A165L-A□M-5D-2	A16L-A□A-5D-2	A165L-A□A-5D-2
		12V		A16L-A□M-12D-2	A165L-A□M-12D-2	A16L-A□A-12D-2	A165L-A□A-12D-2
		24V		A16L-A□M-24D-2	A165L-A□M-24D-2	A16L-A□A-24D-2	A165L-A□A-24D-2
	LED (DC)	5V	SPDT	A16L-J□M-5D-1	A165L-J□M-5D-1	A16L-J□A-5D-1	A165L-J□A-5D-1
		12V		A16L-J□M-12D-1	A165L-J□M-12D-1	A16L-J□A-12D-1	A165L-J□A-12D-1
		24V		A16L-J□M-24D-1	A165L-J□M-24D-1	A16L-J□A-24D-1	A165L-J□A-24D-1
	LED (DC)	5V	DPDT	A16L-J□M-5D-2	A165L-J□M-5D-2	A16L-J□A-5D-2	A165L-J□A-5D-2
		12V		A16L-J□M-12D-2	A165L-J□M-12D-2	A16L-J□A-12D-2	A165L-J□A-12D-2
		24V		A16L-J□M-24D-2	A165L-J□M-24D-2	A16L-J□A-24D-2	A165L-J□A-24D-2

Note: To complete the part number, in place of the □ symbol, specify the color code from the Operator Color Code table below.



Operator Color Codes

(Actual color of yellow pushbuttons more closely resembles amber than true yellow.)





Code	Color
R	Red
Y	Yellow
G	Green
W	White
A	Blue

Note: 1. To order illuminated pushbutton with 110 VAC transformer, replace the voltage code (5, 12, 24, 5D, 12D, 24D) with T1 for 110V or T2 for 220V. The secondary voltage of the transformer is always 24V.

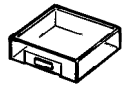

■ ACCESSORIES (ORDER SEPARATELY)

Name	Shape	Classification	Remarks	Part number
Switch guards		Rectangular	Cannot be used with the Dust Cover.	A16ZJ-5050
		Square and round		A16ZA-5050
Dust covers		Rectangular	Cannot be used with the Switch Cover.	A3BJ-5060
		Square		A3BA-5060
		Round		A3BT-5060
Panel plugs		Rectangular	Used for covering the panel cutouts for future panel expansion.	A3BJ-3003
		Square		A3BA-3003
		Round		A3BT-3003

■ REPLACEMENTS

Name	Shape	Classification	Remarks	Part number	
Legend panels		Rectangular	IP40	Opaque	A16ZJ-5204
				Transparent	A16ZJ-5202
			Oil-resistant IP65	Opaque	A16ZJ-5204
				Transparent	A16ZJ-5203
		Square	IP40	Opaque	A16ZA-5204
				Transparent	A16ZA-5202
			Oil-resistant IP65	Opaque	A16ZA-5204
				Transparent	A16ZA-5203
		Round	IP40	Opaque	A16ZT-5204
				Transparent	A16ZT-5202
			Oil-resistant IP65	Opaque	A16ZT-5204
				Transparent	A16ZT-5203
Color caps (for IP40)	Rectangular 	LED indicator/incandescent lamp/non-illuminated	White	A16Z□-5001W	
			Red	A16Z□-5001R	
			Yellow	A16Z□-5001Y	
		LED indicator	Green	A16Z□-5001GY	
			Incandescent lamp/non-illuminated	Blue	A16Z□-5001A
				Green	A16Z□-5001G
	Square 	Non-illuminated	Black	A16Z□-5011B	
			LED indicator/incandescent lamp/non-illuminated	White	A16Z□-5101W
				Red	A16Z□-5101R
		Yellow		A16Z□-5101Y	
		LED indicator	Green	A16Z□-5101GY	
			Incandescent lamp/non-illuminated	Blue	A16Z□-5101A
Green	A16Z□-5101G				
Round 	Non-illuminated	Black	A16Z□-5111B		
		LED indicator/incandescent lamp/non-illuminated	White	A16Z□-5101W	
			Red	A16Z□-5101R	
	Yellow		A16Z□-5101Y		
	LED indicator	Green	A16Z□-5101GY		
		Incandescent lamp/non-illuminated	Blue	A16Z□-5101A	
Green			A16Z□-5101G		

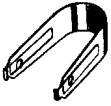
■ TOOLS

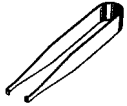
Name	Shape	Applicable types					Remarks	Part number
		Pushbutton Switch	Knob-type Selector Switch	Key-type Selector Switch	E-Stop Switch	Indicator		
Pushbutton switch extractor		Yes	No	No	No	Yes	Convenient for extracting Pushbutton Switches	A3PJ-5080
Screw fitting		Yes	Yes	Yes	Yes	Yes	Convenient for ganged installation. Tighten to a torque of 0.39 N • m (5 kg • cm) min.	A3B-3004
Lamp unit extractor		Yes	Yes	Yes	Yes	Yes	Convenient for extracting the Switch Unit and Lamps.	A16Z-5080

Specifications

■ CHARACTERISTICS

Item		
Allowable operating frequency	Mechanical	Momentary operation: 120 operations/min max. Alternating operation: 60 operations/min max. (See Note 1)
	Electrical	20 operations/min max.
Insulation resistance		100 MΩ min. (at 500 VDC)
Dielectric strength		1,000 VAC, 50/60 Hz for 1 min between terminals of same polarity 2,000 VAC, 50/60 Hz for 1 min between terminals of different polarity and also between each terminal and ground 1,000 VAC, 50/60 Hz for 1 min between lamp terminals (See Note 2)
Vibration resistance	Malfunction	10 to 55 Hz, 1.5-mm double amplitude (malfunction within 1 ms)
Shock resistance	Mechanical	500 m/s ² (50G)
	Malfunction	150 m/s ² (15G) max. (malfunction within 1 ms)
Life expectancy	Mechanical	Momentary operation: 2,000,000 operations min. Alternating operation: 200,000 operations min.
	Electrical	100,000 operations min.
Ambient temperature		Operating: -10°C to 55°C (14°F to 131°F) with no icing or condensation Storage: -25°C to 65°C (-13°F to 149°F) with no icing or condensation
Ambient humidity		Operating: 35% to 85%
Electric shock protection class		Class II
Degree of contamination		3 (IEC947-5-1)
Weight		Approx. 10 g (0.35 oz) in the case of a Illuminated DPDT switch with solder terminals

- Note: 1. Set and reset constitute one operation.
2. With LED and incandescent lamp not mounted.

■ APPROVED STANDARDS

Recognized organization	Standards	File No.
UL, cUL (See Note)	UL508	E41515
ASTA	EN60947-5-1	—

Note: UL: CSA C22 No. 14

■ RATINGS

AC resistive load (AC15)	DC resistive load (DC13)
3 A, 250 VAC 5 A, 125 VAC	3 A, 30 VDC

Minimum applicable load: 1 mA at 5 VDC

Rated values are obtained from tests conducted under the following conditions according to JIS C4505 and C4520.

1. Load: Resistive load
2. Mounting conditions: No vibration and no shock
3. Temperature: 20°±2°C
4. Operating frequency: 20 operations/min

Contact

Name	Contact
SPDT	

LED

Rated voltage	Rated current	Operating voltage	Internal limiting resistor
5 VDC	30 mA	5 VDC±5%	33 Ω
12 VDC	15 mA	12 VDC±5%	270 Ω
24 VDC	10 mA	24 VDC±5%	1600 Ω

■ OPERATING CHARACTERISTICS

Type	Pushbutton Switch			
	IP40		Oil-resistant IP65	
	SPDT	DPDT	SPDT	DPDT
Operating force (OF) max.	2.45 N (250 gf)	4.41 N (450 gf)	2.94 N (300 gf)	4.91 N (500 gf)
Releasing force (RF) min.	0.29 N (30 gf)			
Total travel (TT)	Approx. 3 mm			
Pretravel (PT) max.	2.5 mm			
Lock stroke (LTA) min. (See Note)	0.5 mm			

Note: Lock stroke is only for alternating operation.

■ INDICATORS WITHOUT TRANSFORMER

**Rectangular
M16-J**

Solder terminals (tab terminals #110)

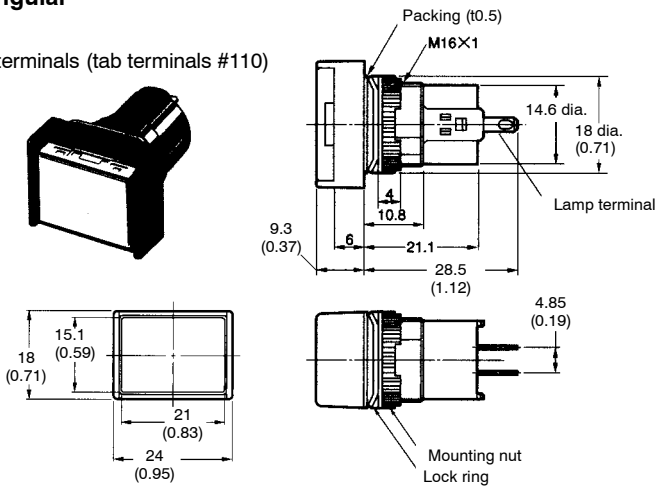

**Panel cutouts
(Top View)**

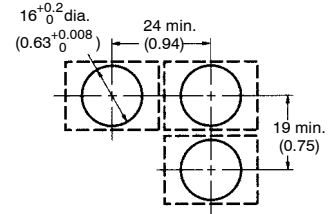

**Square
M16-A**

Solder terminals (tab terminals #110)

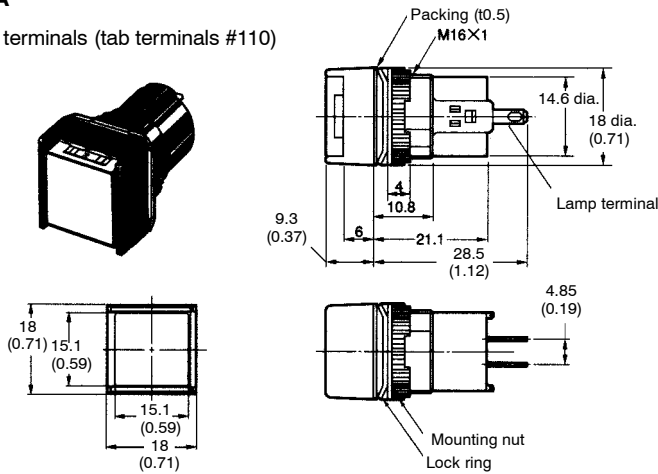

**Panel cutouts
(Top View)**

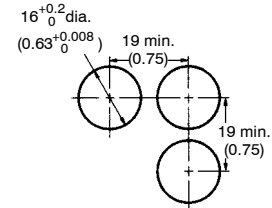

**Round
M16-T**

Solder terminals (tab terminals #110)

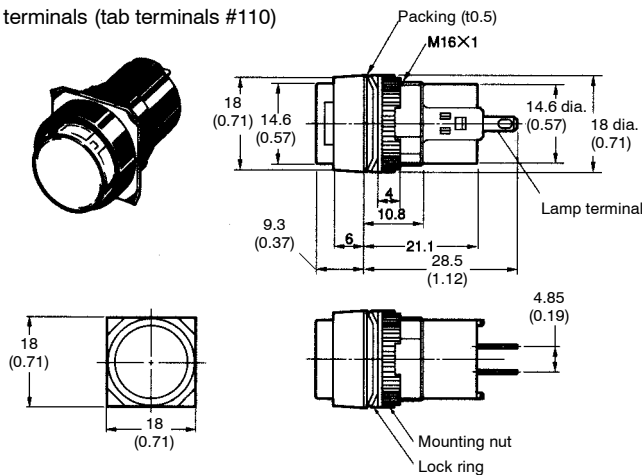

**Panel cutouts
(Top View)**

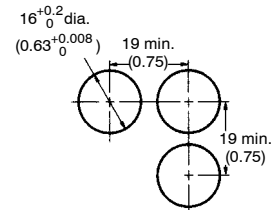

- Note: 1. Make sure the thickness of the mounting panel is between 0.5 and 3.2 mm. If, however, a Switch Guard or Dust Cover is used, the thickness of the mounting panel must be between 0.5 and 2 mm.
2. If a panel is to be finished with coating, etc., make sure that the panel meets the specified dimensions after coating.

Unit: mm (inch)

LAMPS

LED

A16-5D□/-12D□/-24D□

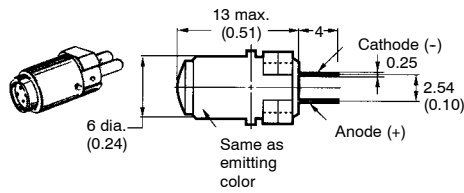

Incandescent Lamp

A16-5/-12/-24

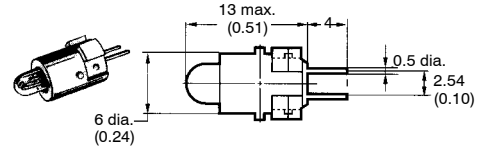

TERMINAL ARRANGEMENT

Non-Illuminated Pushbutton Switches are also provided with lamp terminals.

SPDT Switches

Illuminated type

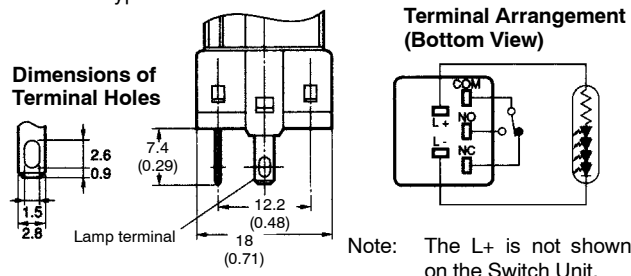

DPDT Switches

Illuminated type

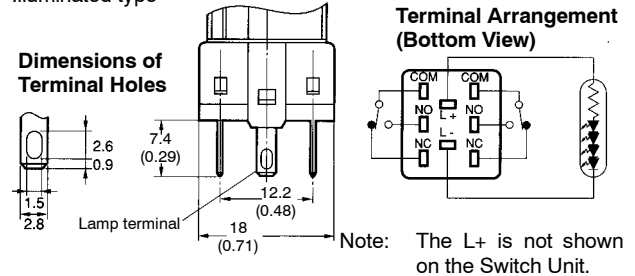

Pilot lights

Dimensions of Terminal Holes

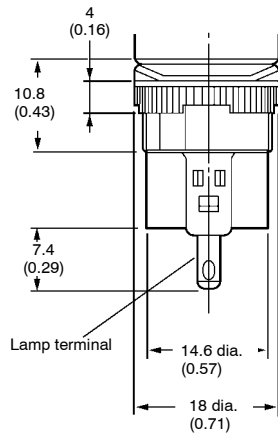
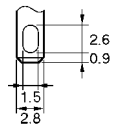

Terminal Arrangement (Bottom View)

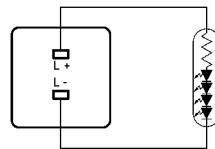

Note: The L+ is not shown on the Switch Unit.

■ ACCESSORIES, TOOLS, AND COMPONENTS

**Pushbutton switch extractor
A3PJ-5080**

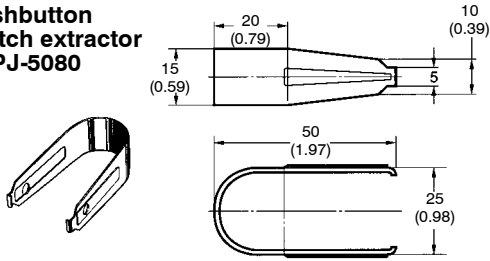

**Legend Panels
A16ZJ-520□**

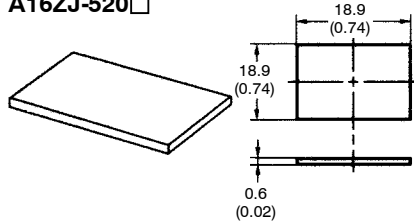

A16ZA-520□

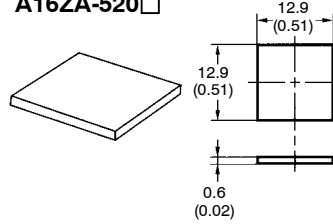

A16ZT-520□

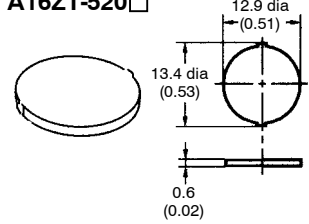

- Note: 1. The panel is 0.6 mm thick.
2. The panel is made of the materials listed in the following table.

Color	Degree of protection	Materials
Opaque	IP40	Polyacrylate resin
	IP65	
Transparent	IP40	Polycarbonate resin
	IP65	Polyacrylate resin

Note: The standard model is transparent.

**Screw Fitting
A3B-3004**

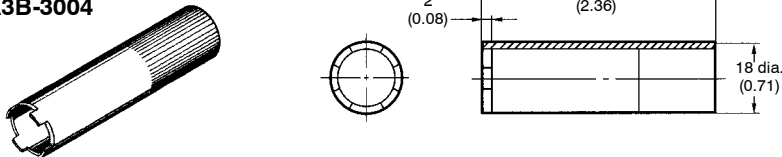

Panel Plugs (Black Resin)

Select the Plug that fits the panel design and mount from the front of the Panel. Panel cutouts are the same as those for Switches.

**Rectangular
A3BJ-3003**

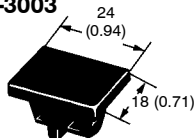

**Square
A3BA-3003**

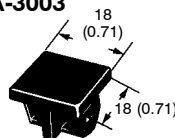

**Round
A3BT-3003**

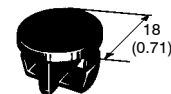

Lock Fitting

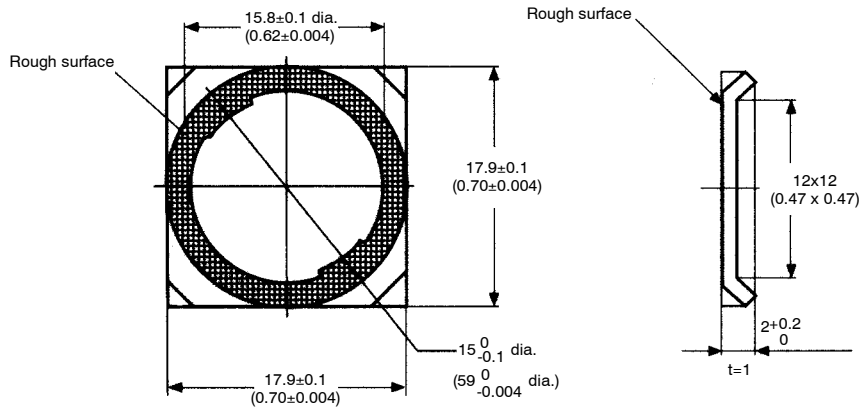

Lamp unit extractor
A16Z-5080

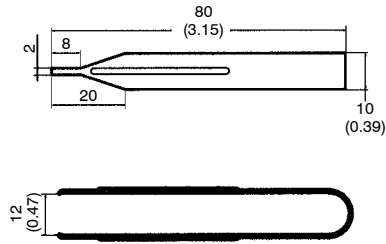
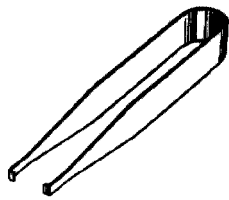

Dimensions When Mounting Accessories

Unit: mm (inch)

SWITCH GUARDS

Rectangular A16ZJ-5050

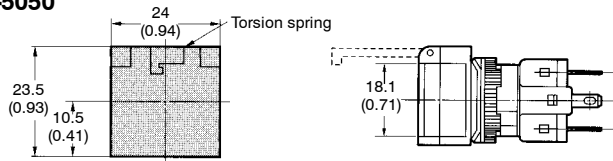

Panel Cutouts (Top View)

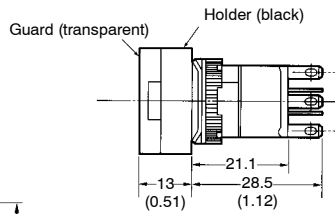
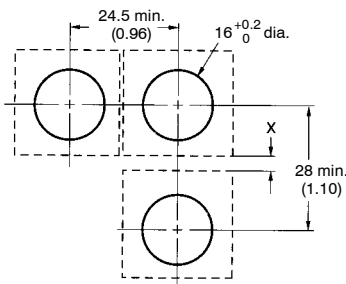

Note: The above illustration shows a case where 4.5 mm is provided for the distance "x." If no clearance is required for the "x" section, the vertical mounting dimension can be as small as 24 mm. Set this distance according to operating conditions.

Square A16ZA-5050

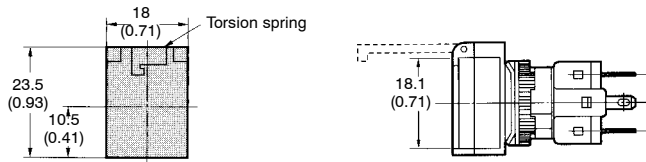

Panel Cutouts (Top View)

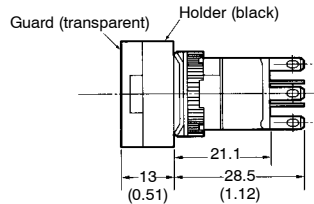
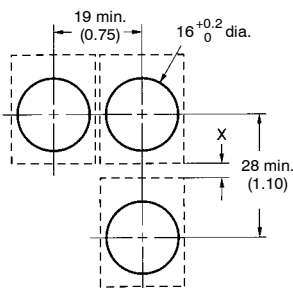

Note: The above illustration shows a case where 4.5 mm is provided for the distance "x." If no clearance is required for the "x" section, the vertical mounting dimension can be as small as 24 mm. Set this distance according to operating conditions.

■ DUST COVERS

**Rectangular
A3BJ-5060**

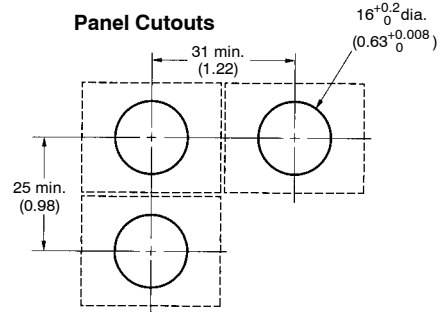
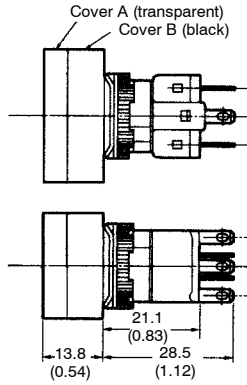
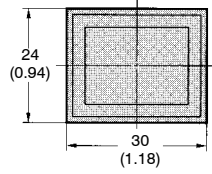

**Square
A3BA-5060**

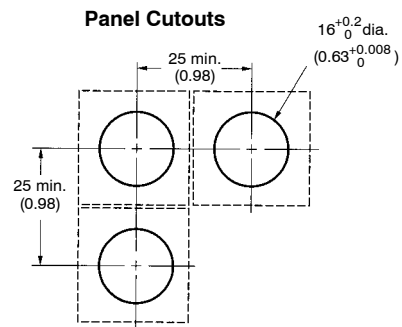
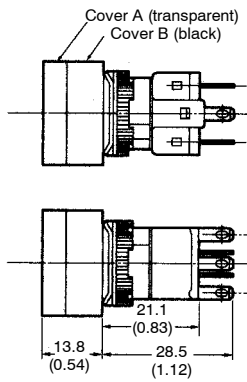
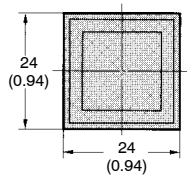

**Round
A16ZT-5050**

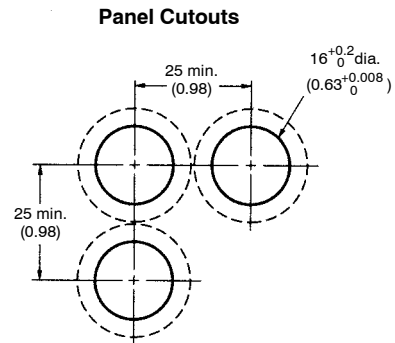
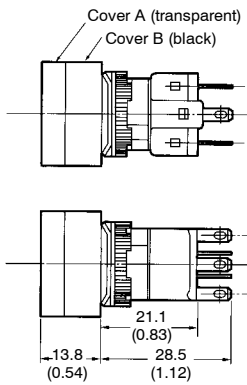
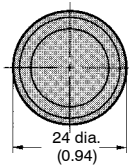

Installation

■ MOUNTING

After mounting the Pushbutton Unit to the panel, snap in the Socket Unit from the back of the panel.

Panel mounting

Insert the Pushbutton Unit into the front of the panel, and fix the lock ring and mounting nut from the terminal side.

Make sure that the lock ring is aligned with the thread of the case and the edge of the lock ring is touching the panel.

Tighten the mounting nuts to a torque of 0.20 to 0.39 N • m (3 to 5 kgf • cm).

The maximum tightening torque is 0.39 N • m (5 kgf • cm).

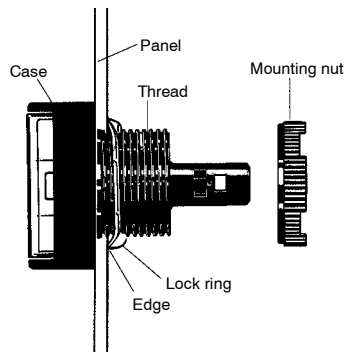

Switch Mounting

Snap on the Switch Unit to the Pushbutton Unit.

Make sure the the Switch Unit is in the proper orientation when snapping on to the Pushbutton Unit.

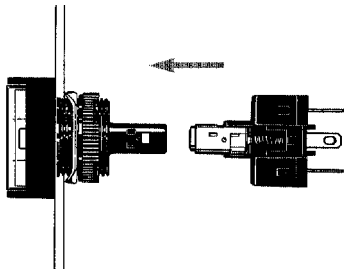

■ SWITCH REMOVAL

Grip the part between the Switch holder of the case and the Switch Unit using the A16Z-5080 Extractor, and pull to remove the Switch Unit.

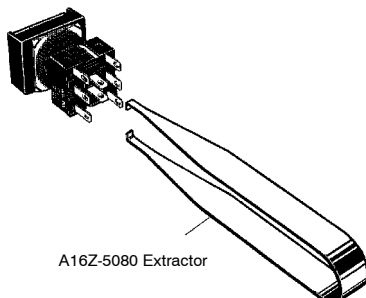

■ REPLACEMENT PARTS

Removal and installation of the Operating Part

1. Remove the operating part as shown in the following diagram. If the operating part cannot be removed by hand, use the A3PJ-5080 Extractor.

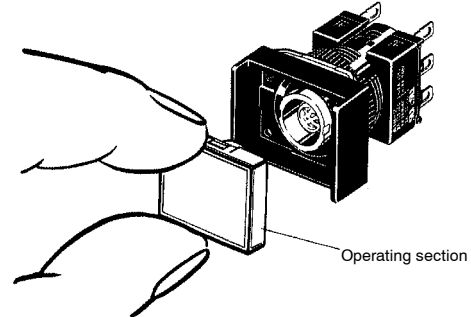

2. To attach the operating part, push until it clicks into place.

■ REMOVING THE LAMP

Removing from the Operating Part End

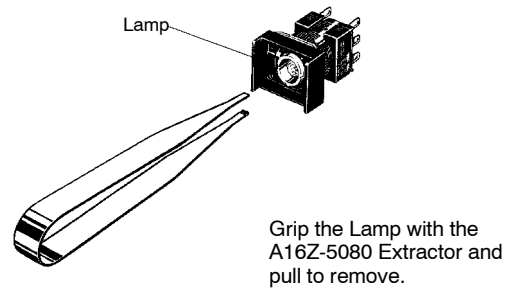

Removing from the Switch Unit End

The Lamp can be removed by hand once the Switch is removed using the A16Z-5080 Extractor.

■ INSTALLING THE LAMP

When mounting the Lamp, make sure it is facing the direction shown in the following diagram. Insert the Lamp while matching the protruding part of the Lamp and the small guides on the outer surface of the case.

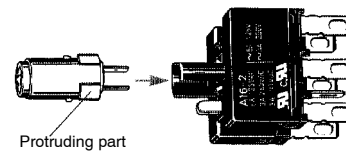

The Lamp can be mounted from the operating part end by using the A16Z-5080 Extractor. The lamp can be mounted by following the opposite procedure for removing the Lamp.

Precautions

! WARNING

Do not apply a voltage between the incandescent lamp and the terminal that is greater than the rated voltage. If the incandescent lamp is broken, the operating part may pop out.

Always turn OFF the power and wait for 10 minutes before replacing the incandescent lamp. If the lamp is replaced immediately after the power is turned OFF, the remaining heat may cause burns.

■ CORRECT USE

Mounting

Always make sure that the power is turned OFF before mounting, removing, or wiring the Switch, or performing maintenance.

Do not tighten the mounting nut more than necessary using tools such as pointed-nose pliers. Doing so will damage the mounting nut. The tightening torque is 0.20 to 0.39 N • m (3 to 5 kgf • cm).

Wiring

Solder terminals and quick-connect terminals (#110) are commonly used for terminals.

Be sure to use electrical wires that are a size appropriate for the applied voltage and carry current (conductor size is 0.5 to 0.75 mm²). Perform soldering according to the conditions provided below. If the soldering is not properly performed, the lead wires will become detached, resulting in short-circuits.

1. Hand soldering: 30 W, within 5 s
2. Dip soldering: 240°C, within 3 s

Wait for one minute after soldering before exerting any external force on the solder.

Use non-corrosive resin fluid as the flux.

Make sure that the electric cord is wired so that it does not touch the Unit. If the electric cord will touch the Unit, then electric wires with a heat resistance of 100°C min. must be used.

After wiring the Switch, maintain an appropriate clearance and creepage distance.

Operating Environment

The IP65 model is designed with a protective structure so that it will not sustain damage if it is subjected to water from any direction to the front of the panel.

Using the Microload

Insert a contact protection circuit, if necessary, to prevent the reduction of life expectancy due to extreme wear on the contacts caused by loads where inrush current occurs when the contact is opened and closed.

The A16 allows both a general-purpose load (125 V at 5A, 250 V at 3 A) and a microload. If a general-purpose load is applied, however, the microload area cannot be used. If the microload area is used with a general-purpose load, the contact surface will become rough, and the opening and closing of the contact for a microload may become unreliable.

The minimum applicable load is the N-level reference value. This value indicates the malfunction reference level for the reliability level of 60% (λ 60) (conforming to JIS C5003).

The equation, λ 60 = $0.5 \times 10^{-4}/\text{time}$ indicates that the estimated malfunction rate is less than 1/2,000,000 with a reliability level of 60%.

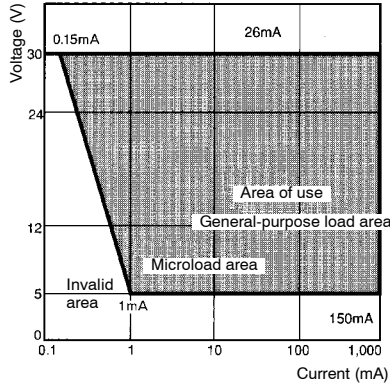

LEDs

The LED current-limiting resistor is built-in, so internal resistance is not required.

Rated voltage	Internal limiting resistor
5 VDC	33 Ω
12 VDC	270 Ω
24 VDC	1600 Ω

Others

The oil-resistant IP65 uses NBR rubber and is resistant to general cutting oil and cooling oil. Some particular oils cannot be used with the oil-resistant IP65, however, so contact your OMRON representative for details.

If the panel is to be finished with coating, etc., make sure that the panel meets the specified dimensions after the coating.

Do not subject the Switch to extreme shock or vibration. Doing so will cause malfunctions and damage to the Switch.

Do not let sharp objects come into contact with the Switches that are made of resin. Doing so will damage the Switches, causing scratches on the outside of the operating parts, and malfunction.

When handling the Switches, do not throw or drop them.

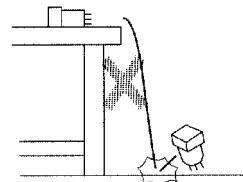

Do not allow the Switch to drop and hit the ground.

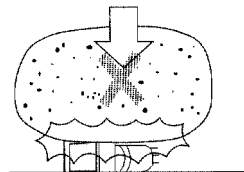

Do not place or drop heavy objects on the Switch.

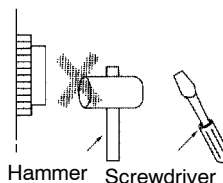

Do not operate the Switch with hard or sharp objects.

Knob-Type Selector Switch

A165S/W

Mounting Aperture of 16 mm

- 2-piece construction requires no tools
- Oil-resistant IP65 models
- Short mounting depth, less than 28.5 mm below panel
- Wide range of switching capacity from general to microload
- Illuminated and non-illuminated models
- 2 and 3-position models
- Maintained and spring return reset
- UL and CSA approved
- Conforms to EN60947-5-1, IEC947-5-1

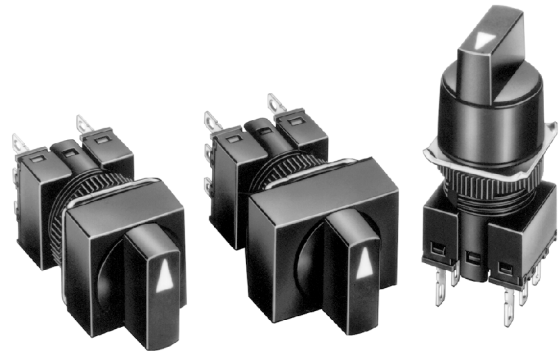

Ordering Information

■ CONSTRUCTION

Flange Shape

Protective Case and Terminal Type

- **Protective Structure**
Oil-resistant IP65
- **Terminal Type**
Solder terminals
(tab terminals #110)

Lamp

- LED

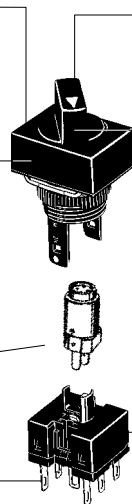

Available Colors

- For LED
Red, green, yellow

Number of Positions and Reset Method

- **2 Positions**
Maintained
Spring return
- **3 Positions**
Maintained
Spring return

Switch Unit Specifications

- **General-purpose Loads**
125 VAC: 5 A
250 VAC: 3 A
30 VDC 3 A
Minimum applicable load: 1 mA at 5 VDC

■ PART NUMBER LEGEND A165 SELECTOR SWITCH (COMPLETE ASSEMBLY)

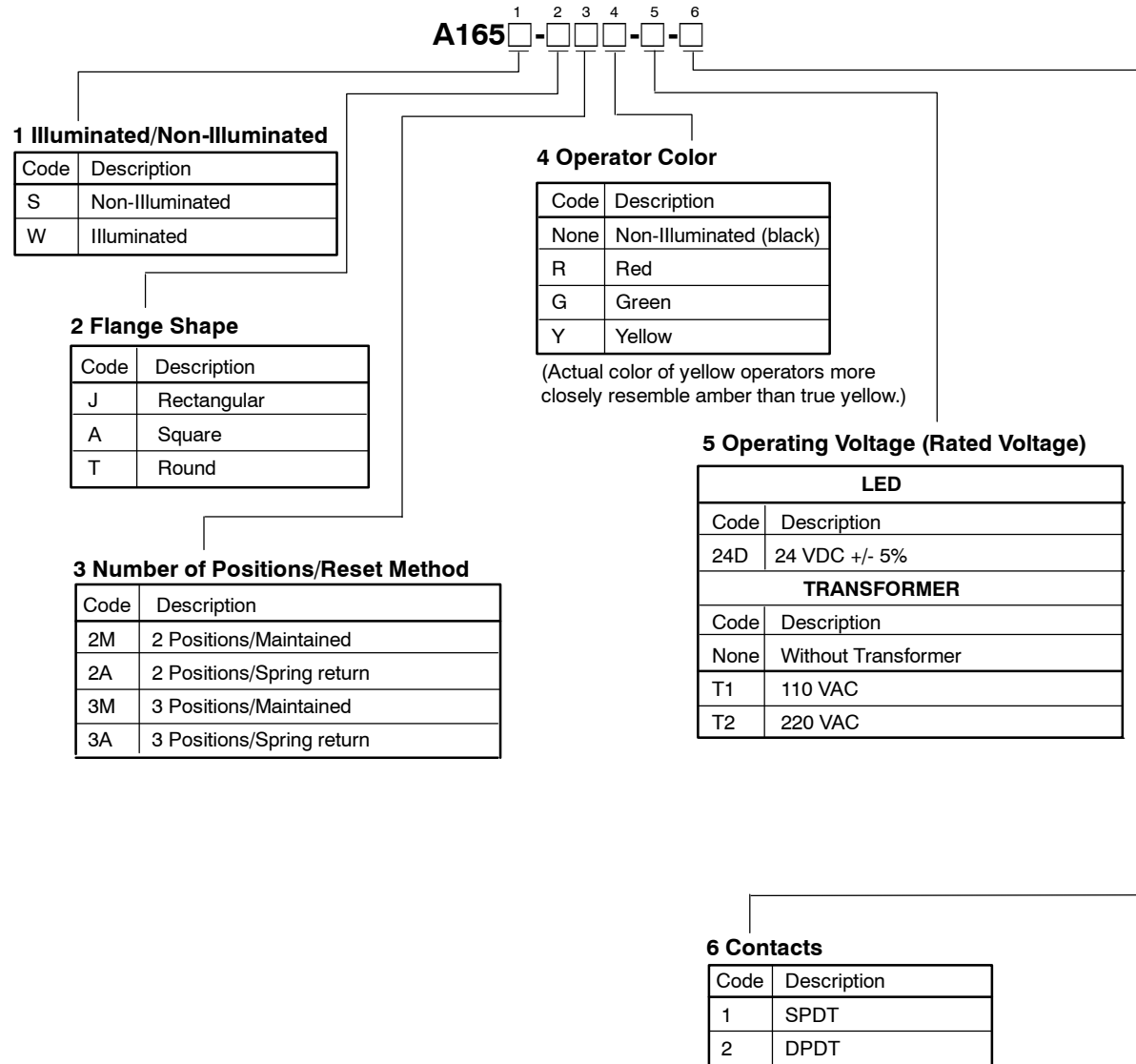

■ PART NUMBERS: A165S ASSEMBLED NON-ILLUMINATED KNOB-TYPE SELECTOR SWITCH
(COMPLETE ASSEMBLY)

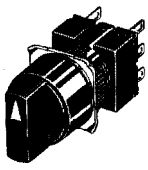
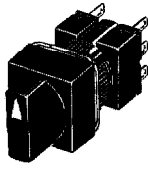
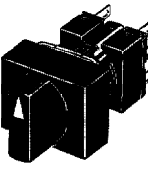
Shape	Number of positions	Contact	Reset method	Part number
Round 	2 positions	SPDT	Maintained	A165S-T2M-1
			Spring return (right)	A165S-T2A-1
	3 positions	DPDT	Maintained	A165S-T2M-2
			Spring return (right)	A165S-T2A-2
			Maintained	A165S-T3M-2
			Spring return (both)	A165S-T3A-2
Square 	2 positions	SPDT	Maintained	A165S-A2M-1
			Spring return (right)	A165S-A2A-1
	3 positions	DPDT	Maintained	A165S-A2M-2
			Spring return (right)	A165S-A2A-2
			Maintained	A165S-A3M-2
			Spring return (both)	A165S-A3A-2
Rectangular 	2 positions	SPDT	Maintained	A165S-J2M-1
			Spring return (right)	A165S-J2A-1
	3 positions	DPDT	Maintained	A165S-J2M-2
			Spring return (right)	A165S-J2A-2
			Maintained	A165S-J3M-2
			Spring return (both)	A165S-J3A-2

■ A165W ILLUMINATED (2 POSITION) KNOB-TYPE SELECTOR SWITCH (COMPLETE ASSEMBLY)

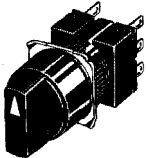
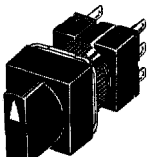
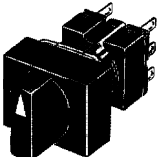
Description				Part number	
Appearance	Type	Rated voltage	Contacts	Maintained	Spring return from right
Round 	Full voltage LED (DC)	24 VDC	SPDT	A165W-T2M□-24D-1	A165W-T2A□-24D-1
		110 VAC		A165W-T2M□-T1-1	A165W-T2A□-T1-1
	Transformer 24 V Secondary	220 VAC	DPDT	A165W-T2M□-T2-1	A165W-T2A□-T2-1
		24 VDC		A165W-T2M□-24D-2	A165W-T2A□-24D-2
	Full voltage LED (DC)	110 VAC	DPDT	A165W-T2M□-T1-2	A165W-T2A□-T1-2
		220 VAC		A165W-T2M□-T2-2	A165W-T2A□-T2-2
	Transformer 24 V Secondary	110 VAC	DPDT	A165W-A2M□-24D-1	A165W-A2A□-24D-1
		220 VAC		A165W-A2M□-T1-1	A165W-A2A□-T1-1
Square 	Full voltage LED (DC)	24 VDC	SPDT	A165W-A2M□-24D-1	A165W-A2A□-24D-1
		110 VAC		A165W-A2M□-T1-1	A165W-A2A□-T1-1
	Transformer 24 V Secondary	220 VAC	DPDT	A165W-A2M□-T2-1	A165W-A2A□-T2-1
		24 VDC		A165W-A2M□-24D-2	A165W-A2A□-24D-2
	Full voltage LED (DC)	110 VAC	DPDT	A165W-A2M□-T1-2	A165W-A2A□-T1-2
		220 VAC		A165W-A2M□-T2-2	A165W-A2A□-T2-2
	Transformer 24 V Secondary	110 VAC	DPDT	A165W-J2M□-24D-1	A165W-J2A□-24D-1
		220 VAC		A165W-J2M□-T1-1	A165W-J2A□-T1-1
Rectangular 	Full voltage LED (DC)	24 VDC	SPDT	A165W-J2M□-24D-1	A165W-J2A□-24D-1
		110 VAC		A165W-J2M□-T1-1	A165W-J2A□-T1-1
	Transformer 24 V Secondary	220 VAC	DPDT	A165W-J2M□-T2-1	A165W-J2A□-T2-1
		24 VDC		A165W-J2M□-24D-2	A165W-J2A□-24D-2
	Full voltage LED (DC)	110 VAC	DPDT	A165W-J2M□-T1-2	A165W-J2A□-T1-2
		220 VAC		A165W-J2M□-T2-2	A165W-J2A□-T2-2
	Transformer 24 V Secondary	110 VAC	DPDT	A165W-J2M□-T1-2	A165W-J2A□-T1-2
		220 VAC		A165W-J2M□-T2-2	A165W-J2A□-T2-2

Note: To complete the part number, replace the □ symbol with the appropriate color code from the *Operator Color Code* table below.

Operator Color Codes

(Actual color of yellow pushbuttons more closely resembles amber than true yellow).

Code	Color
R	Red
Y	Yellow
G	Green

■ A165W ILLUMINATED (3 POSITION) KNOB-TYPE SELECTOR SWITCH (COMPLETE ASSEMBLY)

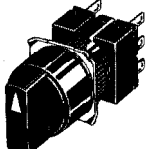
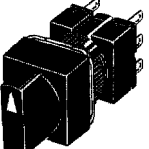
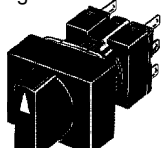
Description				Part number	
Appearance	Type	Rated voltage	Contacts	Maintained	Spring return from both
Round 	Full voltage LED (DC) Transformer 24 V Secondary	24 VDC	DPDT	A165W-T3M□-24D-2	A165W-T3A□-24D-2
		110 VAC		A165W-T3M□-T1-2	A165W-T3A□-T1-2
		220 VAC		A165W-T3M□-T2-2	A165W-T3A□-T2-2
Square 	Full voltage LED (DC) Transformer 24 V Secondary	24 VDC	DPDT	A165W-A3M□-24D-2	A165W-A3A□-24D-2
		110 VAC		A165W-A3M□-T1-2	A165W-A3A□-T1-2
		220 VAC		A165W-A3M□-T2-2	A165W-A3A□-T2-2
Rectangular 	Full voltage LED (DC) Transformer 24 V Secondary	24 VDC	DPDT	A165W-J3M□-24D-2	A165W-J3A□-24D-2
		110 VAC		A165W-J3M□-T1-2	A165W-J3A□-T1-2
		220 VAC		A165W-J3M□-T2-2	A165W-J3A□-T2-2

Note: To complete the part number, replace the □ symbol with the appropriate color code from the Operator *Color Code* table below.

Operator Color Codes

(Actual color of yellow pushbuttons more closely resembles amber than true yellow).

Code	Color
R	Red
Y	Yellow
G	Green

Accessories (Order Separately)

■ PANEL PLUGS

Shape	Classification	Remarks	Part number
	Rectangular	Used for covering the panel cutouts for future panel expansion.	A3BJ-3003
	Square		A3BA-3003
	Round		A3BT-3003

■ TOOLS

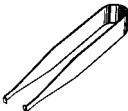
Name	Shape	Applicable types					Remarks	Part number
		Pushbutton Switch	Knob-type Selector Switch	Key-type Selector Switch	Emergency Stop Switch	Pilot Light		
Screw fitting		Yes	Yes	Yes	Yes	Yes	Convenient for ganged installation. Tighten to a torque of 0.39 N • m (5 kgf • cm) min.	A3B-3004
Extractor		Yes	Yes	Yes	Yes	Yes	Convenient for extracting the Switch Unit and Lamps.	A16Z-5080

Specifications

■ APPROVED STANDARDS

UL, cUL (File No. E41515)

5 A at 125 VAC, 3 A at 250 VAC (general use)
3 A at 30 VDC (resistive)

EN60947-5-1 (Low Voltage Directive)

■ RATINGS

AC resistive load (AC15)	DC resistive load (DC13)
3 A, 250 VAC 5 A, 125 VAC	3 A, 30 VDC

Minimum applicable load: 1 mA at 5 VDC

Rated values are obtained from tests conducted under the following conditions according to JIS C4505 and C4520.

1. Load: Resistive load
2. Mounting conditions: No vibration and no shock
3. Temperature: 20°±2°C (68F°±3.6F°)
4. Operating frequency: 20 times/min

■ CONTACT

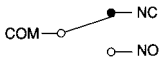
Name	Contact
SPDT	

■ LED

Rated voltage	Rated current	Operating voltage	Internal limiting resistor
24 VDC	10 mA	24 VDC±5%	1600 Ω

■ CHARACTERISTICS

Item	Knob-type Selector Switch	
Allowable operating frequency (See Note 1.)	Mechanical	20 operations/min max.
	Electrical	10 operations/min max.
Insulation resistance	100 M Ω min. (at 500 VDC)	
Dielectric strength	1,000 VAC, 50/60 Hz for 1 min between terminals of same polarity 2,000 VAC, 50/60 Hz for 1 min between terminals of different polarity and also between each terminal and ground 1,000 VAC, 50/60 Hz for 1 min between lamp terminals (See note 2)	
Vibration resistance	Malfunction	10 to 55 Hz, 1.5-mm double amplitude (malfunction within 1 ms)
Shock resistance	Mechanical	500 m/s ² (50G)
	Malfunction	150 m/s ² (15G) max. (malfunction within 1 ms)
Life expectancy	Mechanical	250,000 operations min.
	Electrical	100,000 operations min.
Ambient temperature	Operating: -10°C to 55°C (14°F to 131°F) with no icing or condensation Storage: -25°C to 65°C (-13°F to 149°F) with no icing or condensation	
Ambient humidity	Operating: 35% to 85%	
Electric shock protection class	Class II	
Degree of contamination	3 (IEC947-5-1)	
Weight	Approx. 13 g (0.46 oz) in the case of a Illuminated DPDT switch	

- Note: 1. Set and reset constitute one operation.
2. With LED and incandescent lamp not mounted.

■ OPERATING CHARACTERISTICS

Features	Knob-type Selector Switch	
	2 Positions	3 Positions
Operating force (OF) max.	0.1 N • m (1,000 gf • cm)	
Set position (SP)	90 \pm 5°	45 \pm 10°

■ OPERATION ANGLE

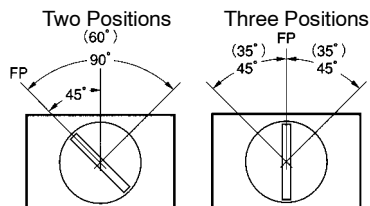

- Note: The angle used for automatic reset is shown in parentheses.

■ CONTACTS

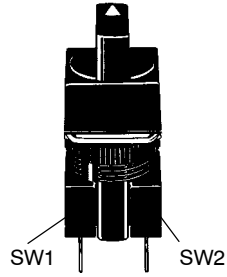

Position	Contact				
	SPDT		DPDT		
	Position	SW	Position	SW1	SW2
2 Positions					
3 Positions	—				

Dimensions

Unit: mm (inch)

■ KNOB-TYPE SELECTOR SWITCHES WITHOUT TRANSFORMER

Rectangular A165□-J

Solder terminals

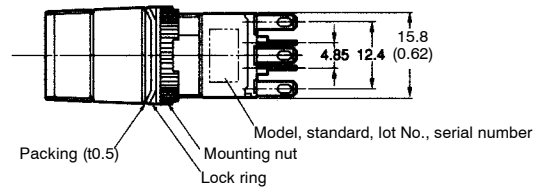
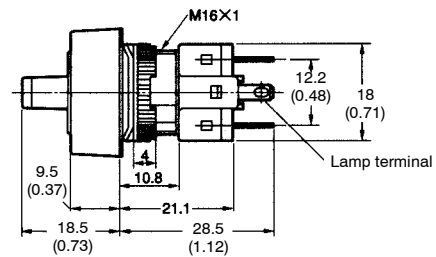
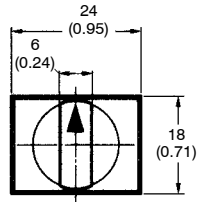
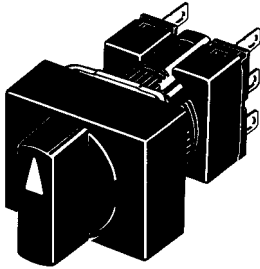

Square A165□-A

Solder terminals

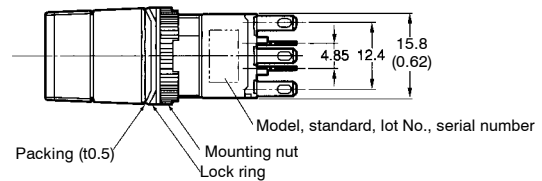
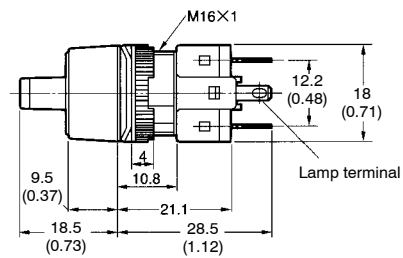
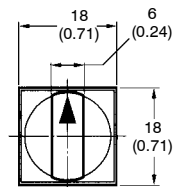
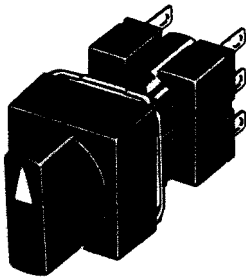

Round A165□-T

Solder terminals

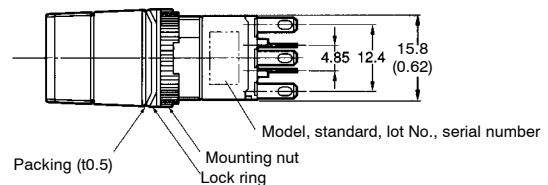
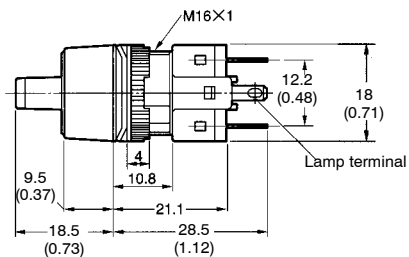
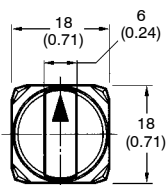
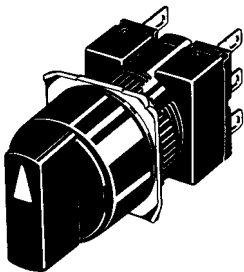

■ PANEL CUTOUTS

Rectangular A165□-J

(Top View)

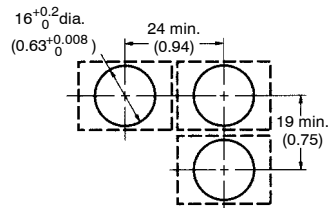

Square A165□-A Round A165□-T

(Top View)

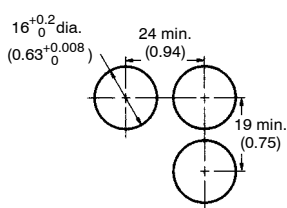

- Note:
1. Make sure the thickness of the mounting panel is between 0.5 and 3.2 mm. If, however, a Switch Guard or Dust Cover is used, the thickness of the mounting panel must be between 0.5 and 2 mm.
 2. If the panel is to be finished with coating, etc., make sure that the panel meets the specified dimensions after coating.

■ TERMINAL ARRANGEMENT

Without Transformer

Lamp terminals are not provided with the Non-illuminated Knob-type Selector Switches and Key-type Selector Switches.

SPDT Switches

Illuminated type

Dimensions of Terminal Holes

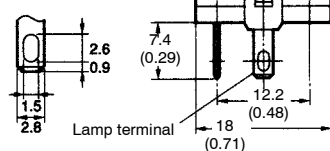

Terminal Arrangement (Bottom View)

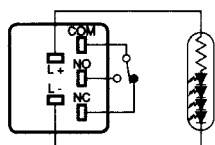

Note: The L+ is not shown on the Switch Unit.

DPDT Switches

Illuminated type

Dimensions of Terminal Holes

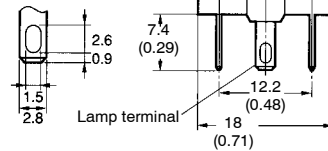

Terminal Arrangement (Bottom View)

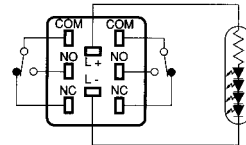

Note: The L+ is not shown on the Switch Unit.

Installation

For details on Panel Mounting, mounting and removing the Switch Unit, refer to installation details for the A16 Pushbutton Switch.

■ FLANGE ROTATION (COMMON TO ALL SELECTOR SWITCHES)

A165 Knob-type Selector Switch

Fix the Switch screw and rotate the flange in 45° turns.

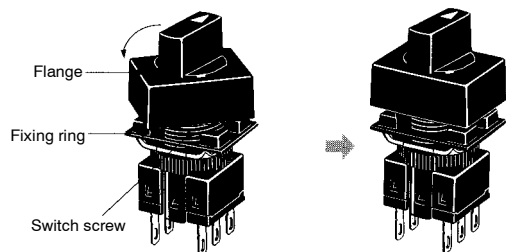

Key-Type Selector Switch

A165K

Mounting Aperture of 16 mm

- Tool-free installation
- 2-piece construction
- Oil-resistant IP65 models
- Short mounting depth, less than 28.5 mm below panel
- Wide range of switching capacity from general to microload
- Maintained and spring return models available
- UL and CSA approved, VDE (pending)
- Conforms to EN60947-5-1, IEC947-5-1

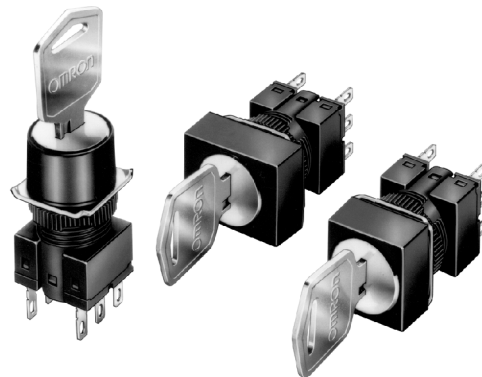

Ordering Information

■ CONSTRUCTION

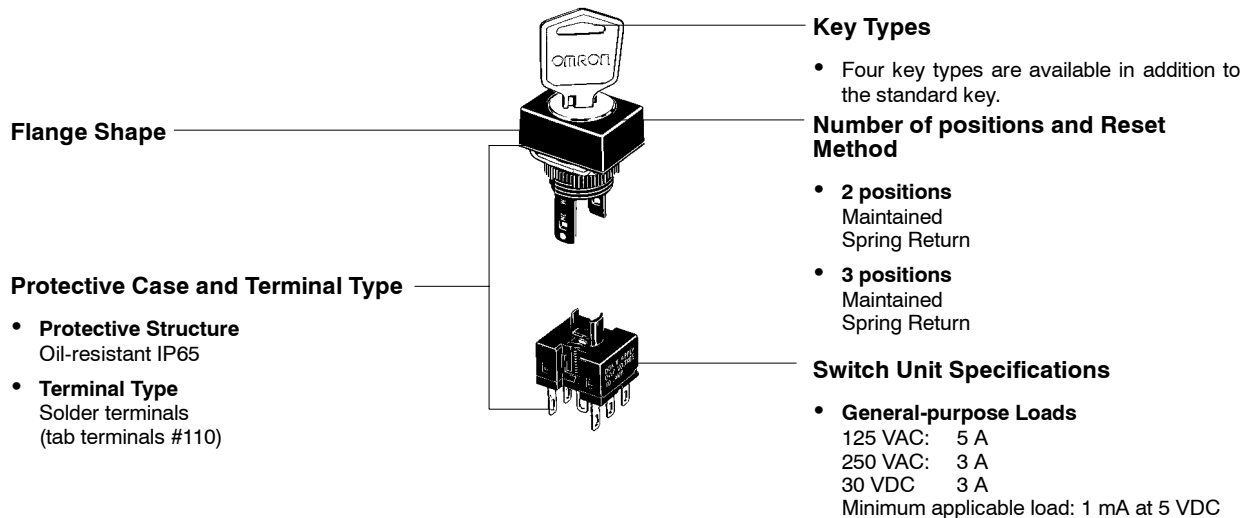

■ PART NUMBER NOMENCLATURE A165K ASSEMBLED KEY-TYPE SELECTOR SWITCH (COMPLETE ASSEMBLY)

A165K-J

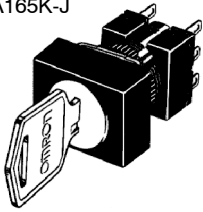

A165K-A

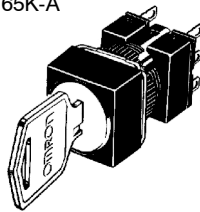

A165K-T

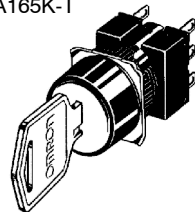

A165K-12345

1 Flange Shape

Code	Shape
T	Round
A	Square
J	Rectangular

4 Key Release Position

Code	Position
None	All
C	Center
R	Right
L	Left

2 Number of Positions

Code	Description
2	2 Position
3	3 Position

5 Contacts

Code	Description
1	SPDT
2	DPDT

3 Reset Method

Code	Description
M	Maintained
A	Spring returned

■ PART NUMBERS: NON-ILLUMINATED KEY-TYPE SELECTOR SWITCH (COMPLETE ASSEMBLY)

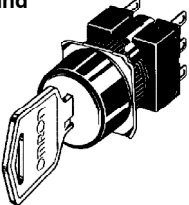
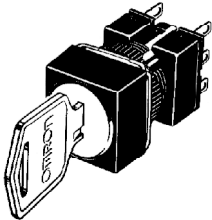
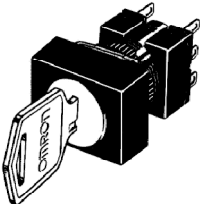
Shape	Number of positions	Contact	Reset method	Key release position	Part number	
Round 	2 positions	SPDT	Maintained	Left	A165K-T2ML-1	
				Right	A165K-T2MR-1	
				All	A165K-T2M-1	
		DPDT	Maintained	Spring return (right)	Left	A165K-T2AL-1
				Left	A165K-T2ML-2	
				Right	A165K-T2MR-2	
	3 positions	DPDT	Maintained	All	A165K-T2M-2	
				Spring return (right)	Left	A165K-T2AL-2
				Center	A165K-T3MC-2	
				Right	A165K-T3MR-2	
Square 	2 positions	SPDT	Maintained	Left	A165K-A2ML-1	
				Right	A165K-A2MR-1	
				All	A165K-A2M-1	
		DPDT	Maintained	Spring return (right)	Left	A165K-A2AL-1
				Left	A165K-A2ML-2	
				Right	A165K-A3MR-2	
	3 positions	DPDT	Maintained	All	A165K-A2M-2	
				Spring return (right)	Left	A165K-A2AL-2
				Center	A165K-A3MC-2	
				Right	A165K-A3MR-2	
Rectangular 	2 positions	SPDT	Maintained	Left	A165K-J2ML-1	
				Right	A165K-J2MR-1	
				All	A165K-J2M-1	
		DPDT	Maintained	Spring return (right)	Left	A165K-J2AL-1
				Left	A165K-J2ML-2	
				Right	A165K-J2MR-2	
	3 positions	DPDT	Maintained	All	A165K-J2M-2	
				Spring return (right)	Left	A165K-J2AL-2
				Center	A165K-J3MC-2	
				Right	A165K-J3MR-2	
3 positions	DPDT	Maintained	Left	A165K-J3ML-2		
			All	A165K-J3M-2		
			Spring return (both)	Center	A165K-J3AC-2	

Accessories (Order Separately)

■ PANEL PLUGS

Shape	Classification	Remarks	Part number
	Rectangular	Used for covering the panel cutouts for future panel expansion.	A3BJ-3003
	Square		A3BA-3003
	Round		A3BT-3003

■ TOOLS

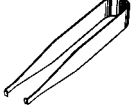
Name	Shape	Applicable types					Remarks	Part number
		Pushbutton Switch	Knob-type Selector Switch	Key-type Selector Switch	Emergency Stop Switch	Indicator		
Screw fitting		Yes	Yes	Yes	Yes	Yes	Convenient for ganged installation. Tighten to a torque of 0.39 N • m (5 kgf • cm) min.	A3B-3004
Extractor		Yes	Yes	Yes	Yes	Yes	Convenient for extracting the Switch Unit and Lamps.	A16Z-5080

Specifications

■ APPROVED STANDARDS

UL, cUL (File No. E41515)

5 A at 125 VAC, 3 A at 250 VAC (general use)

3 A at 30 VDC (resistive)

EN60947-5-1 (Low Voltage Directive)

■ RATINGS

AC resistive load	DC resistive load
3 A, 250 VAC 5 A, 125 VAC	3 A, 30 VDC

Minimum applicable load: 1 mA at 5 VDC

Rated values are obtained from tests conducted under the following conditions according to JIS C4505 and C4520.

1. Load: Resistive load
2. Mounting conditions: No vibration and no shock
3. Temperature: 20°±2°C
4. Operating frequency: 20 times/min

■ CONTACT

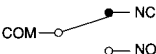
Name	Contact
SPDT	

■ CHARACTERISTICS

Item	Key-type Selector Switch	
Allowable operating frequency	Mechanical	20 operations/min max.
	Electrical	10 operations/min max.
Insulation resistance	100 MΩ min. (at 500 VDC)	
Dielectric strength	1,000 VAC, 50/60 Hz for 1 min between terminals of same polarity 2,000 VAC, 50/60 Hz for 1 min between terminals of different polarity and also between each terminal and ground	
Vibration resistance	Malfunction	10 to 55 Hz, 1.5-mm double amplitude (malfunction within 1 ms)
Shock resistance	Mechanical	500 m/s ² (50G)
	Malfunction	150 m/s ² (15G) max. (malfunction within 1 ms)
Life expectancy	Mechanical	250,000 operations min. (life of key: 10,000 operations min.)
	Electrical	100,000 operations min.
Ambient temperature	Operating: -10°C to 55°C (14°F to 131°F) with no icing or condensation Storage: -25°C to 65°C (-13°F to 149°F) with no icing or condensation	
Ambient humidity	Operating: 35% to 85%	
Electric shock protection class	Class II	
Degree of contamination	3 (IEC947-5-1)	
Weight	Approx. 26.5 g (0.93 oz) in the case of a DPDT switch key	

Note: Set and reset constitute one operation.

■ OPERATING CHARACTERISTICS

	Type	Key-type Selector Switch	
Features		2 positions	3 positions
Operating force (OF) max.		9.8 N • m (1,000 gf • cm)	
Set position (SP)		90±5°	45±10°

■ OPERATION ANGLE

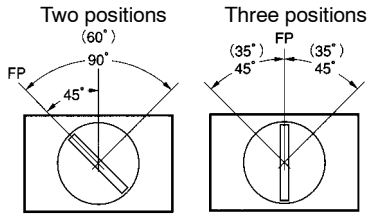

Note: The angle used for automatic reset is shown in parentheses.

■ CONTACTS

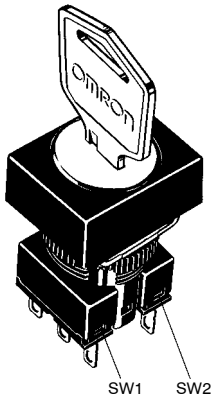

Position	Contact				
	SPDT		DPDT		
	Position	SW	Position	SW1	SW2
2 positions					
3 positions	—				
	—				
	—				

Dimensions

Unit: mm (inch)

KEY-TYPE SELECTOR SWITCHES

Rectangular A165K-J

Solder terminals

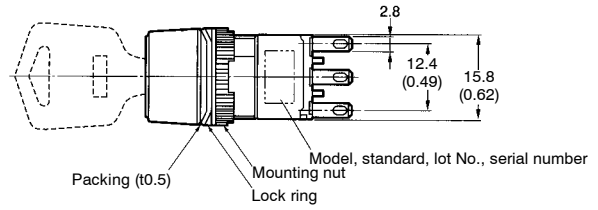
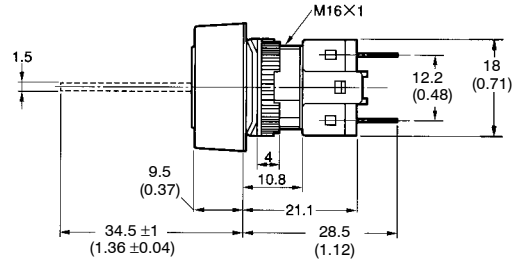
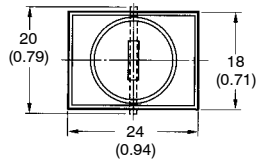
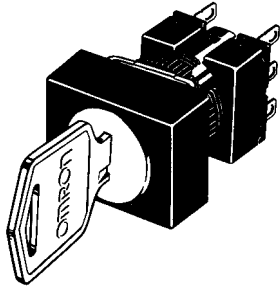

Square A165K-A

Solder terminals

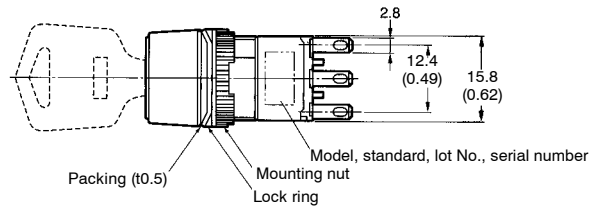
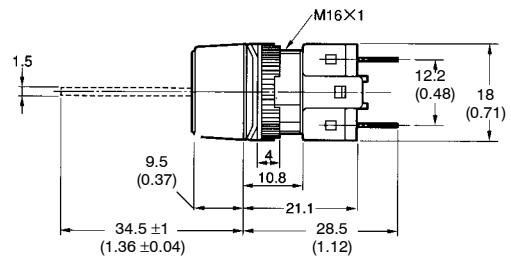
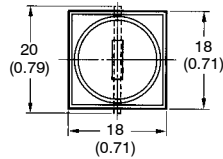
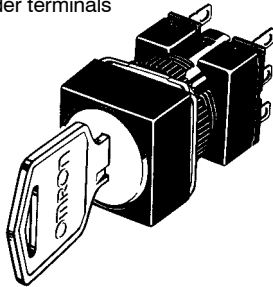

Round A165K-T

Solder terminals

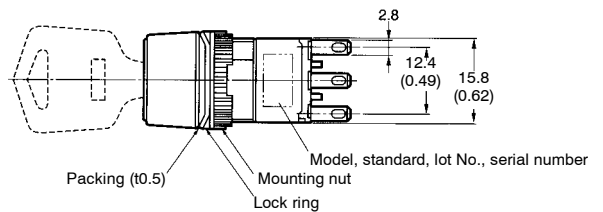
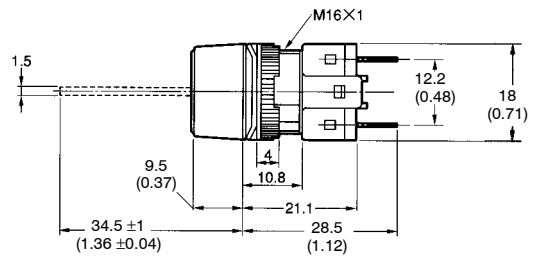
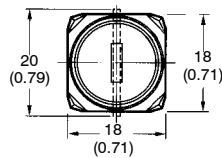
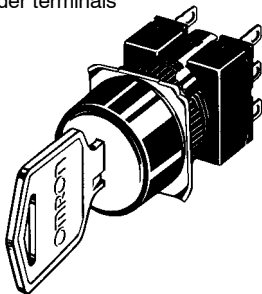

■ PANEL CUTOUTS

Rectangular
A165□-J

(Top View)

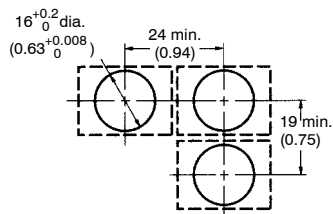

Square A165□-A
Round A165□-T

(Top View)

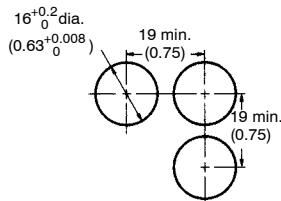

- Note: 1. Make sure the thickness of the mounting panel is between 0.5 and 3.2 mm. If, however, a Switch Guard or Dust Cover is used, the thickness of the mounting panel must be between 0.5 and 2 mm.
2. If the panel is to be finished with coating, etc., make sure that the panel meets the specified dimensions after coating.

■ TERMINAL ARRANGEMENT

SPDT Switches

Dimensions of
Terminal Holes

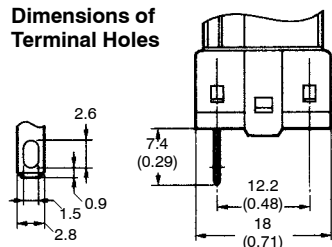

Terminal Arrangement
(Bottom View)

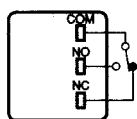

DPDT Switches

Dimensions of
Terminal Holes

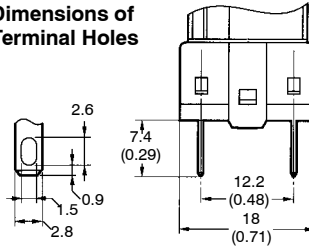

Terminal Arrangement
(Bottom View)

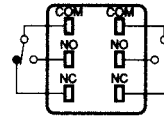

Installation

For mounting and removal instructions refer to the *Installation* section of the A16 Pushbutton switch.

■ FLANGE ROTATION

A165 Key-type Selector Switch

Fix the Switch screw and rotate the flange in 45° turns.

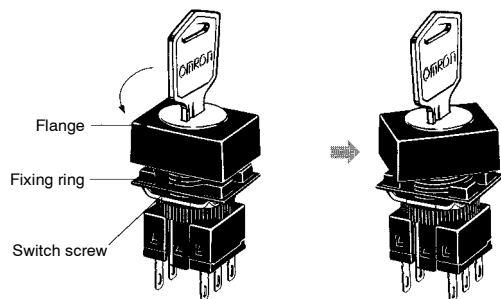

Buzzer

M2BJ-B

16-mm Diameter Panel-Mounted Buzzer Unit



- Four models offer eight different types of sounds, plus two modes newly added to the high-sound type
- Intermittent or continuous sound selected by jumper setting
- Three supply voltages: 6 VAC/DC, 12-24 VDC and 12 to 24 VAC/DC
- Jumper storage provided at bottom of unit
- Complements the A16 range of Pushbuttons, Selector Switches, and Key Switches



Ordering Information

Item		Part number					
		Standard sound				High sound	
Sound	w/jumper	Intermittent	Intermittent (short)	Intermittent (high-pitched)	Intermittent (short, high-pitched)	Intermittent (high-pitched)	Intermittent (short)
	w/o jumper	Continuous	Intermittent (long)	Continuous (high-pitched)	Intermittent (long, high-pitched)	Continuous	Intermittent (long)
Supply voltage	6 VAC/DC	M2BJ-B06	M2BJ-B06A	M2BJ-B06B	M2BJ-B06C	M2BJ-BH06D	M2BJ-BH06E
	12 to 24 VAC/DC	M2BJ-B24	M2BJ-B24A	M2BJ-B24B	M2BJ-B24C	M2BJ-BH24D	M2BJ-BH24E
	12 to 24 DC	M2BJ-B24-D	—	M2BJ-B24B-D	—	M2BJ-BH24D-D	M2BJ-BH24E-D

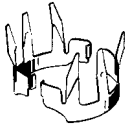
■ ACCESSORIES (ORDER SEPARATELY)

Name	Shape	Classification	Remarks	Part number
Snap-in mounting leaf spring		—	Cannot be used with mounting nut Panel cutout becomes 16.2 dia. + 0.3, -0	A3B-3001
Panel plug		Rectangular	Reserves hole cut out on panel for future mounting	A3BJ-3003
		Square		A3BA-3003
		Round		A3BT-3003
Tightening tool		—	Useful for mounting buzzers one after another. Do not over-tighten.	A3B-3004

Specifications

■ STANDARD-SOUND TYPE

Rated voltage	6 VAC/DC	M2BJ-B06	M2BJ-B06A	M2BJ-B06B	M2BJ-B06C
	12 to 24 VAC/DC	M2BJ-B24	M2BJ-B24A	M2BJ-B24B	M2BJ-B24C
Sound pressure (distance: 0.1 m, at rated voltage)		Continuous sound: 80 dB min.	Continuous: 80 dB min.	Continuous sound: 80 dB min.	Continuous: 80 dB min.
Driving frequency		2±0.5 kHz		4±0.5 kHz	
Intervals		190 times/minute±10%	Long: 55 times/minute±10% Short: 700 times/minute±10%	190 times/minute±10%	Long: 55 times/minute±10% Short: 700 times/minute±10%
Current consumption	DC	7 mA	7 mA	20 mA	20 mA
	AC	20 mA	20 mA	20 mA	20 mA
Life expectancy		1,000 hours min.			

■ HIGH-SOUND TYPE

Item	High-sound type					
	M2BJ-BH06D	M2BJ-BH24D	M2BJ-BH06E	M2BJ-BH24E	M2BJ-BH24D-D	M2BJ-BH24E-D
Rated voltage	6 VAC/DC	12 to 24 VAC/DC	6 VAC/DC	12 to 24 VAC/DC	12 to 24 VDC	
Sound pressure (adjustable range) (rated voltage, distance of 0.1 m, A range)	70 to 100 dB (Adjustable range)					
Driving frequency	2.8±0.5 kHz					
Intervals	Approx. 190 times/min.		Long: Approx. 55 times/min. Short: Approx. 700 times/min.		Approx. 190 times/min.	Long: Approx. 55 times/min. Short: Approx. 700 times/min.
Current consumption	DC	50 mA max.				
	AC	100 mA max.			—	
Inrush current	1 A max.					
Life expectancy	1,000 hours min.					

■ CHARACTERISTICS

Insulation resistance	100 MΩ min. (between ground and current-carrying parts)
Dielectric strength	1,000 VAC for 1 minute (between grounds)
Ambient temperature	Operating: -10°C to 55°C (14°F to 131°F) with no icing or condensation Storage: -25°C to 65°C (-13°F to 149°F) with no icing or condensation
Humidity	35% to 85% RH

Dimensions

Unit: mm (inch)

M2BJ-B

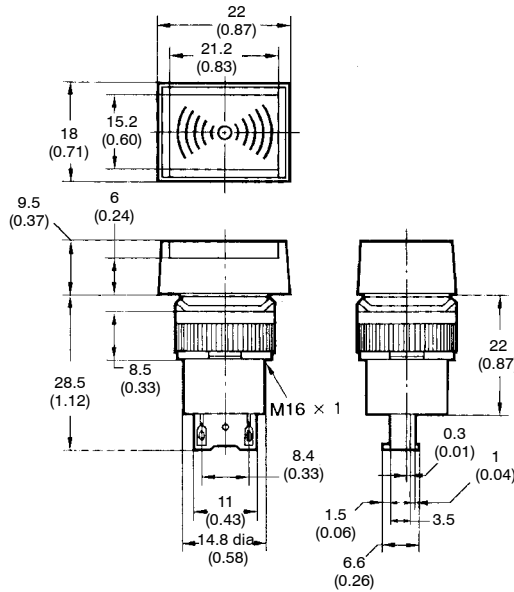
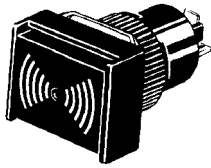

Panel cutout (Top view)

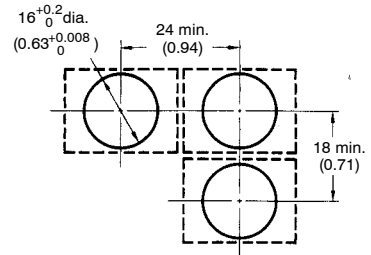

M2BJ-BH

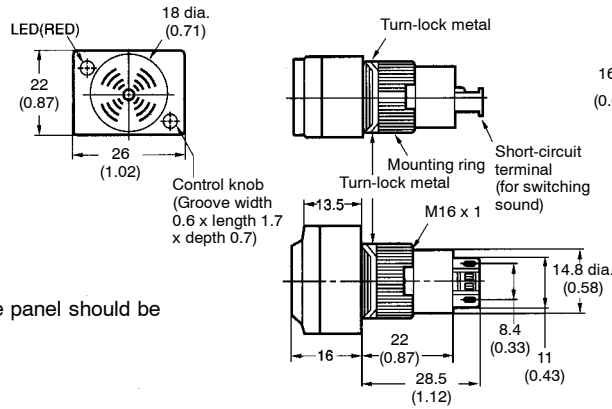
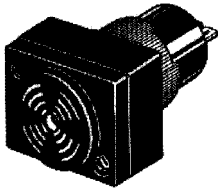

Panel cutout*

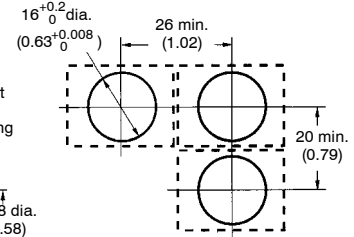

Note: Plate thickness of the panel should be 1.0 to 3.2 mm.

Unit: mm (inch)

■ ACCESSORIES

Tightening Tool

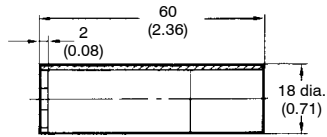
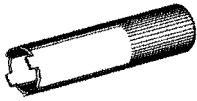

Panel Plug

Select a panel plug which best compliments the design of the mounting panel. The dimensions of the hole cutout for the panel plugs are the same as those of the buzzer unit.

Rectangular

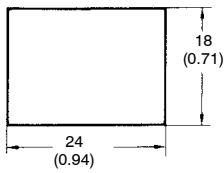

Square

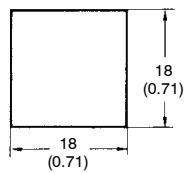

Round

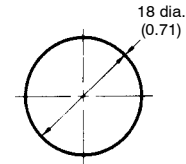

Correct Use

■ NUT MOUNTING

Insert the buzzer unit from the front of the panel and tighten the mounting nut inserted from the rear of the panel.

Since a projection exists on the rear portion of the buzzer unit, if the mounting nut cannot be fitted into position, turn the nut slightly.

The tightening torque of the mounting nut should be less than 5 kg-cm.

Solder the terminals after mounting the nut. Otherwise, the terminals, when thickened by solder, may prevent the nut from being screwed down onto the buzzer unit.

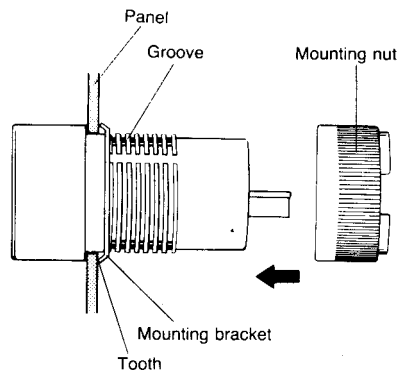

■ MOUNTING

Tighten the mounting nut at a torque of less than 5 kg-cm.

■ WIRING

Exercise caution that the input terminals are not short-circuited by the short-circuiting jumper.

Finish soldering within 5 seconds with a 30 watt soldering iron, or within 3 seconds at a solder temperature of 240°C. For about a minute after soldering, do not apply any force to the buzzer unit, to avoid deforming the softened plastic buzzer unit base.

Use a non-corrosive, resin-based soldering flux.

■ SNAP-IN MOUNTING

Attach the mounting leaf spring to the buzzer. Engage the edges of the leaf spring in the two grooves on the threaded section of the buzzer. After inserting the leaf spring edges into the grooves, confirm that the leaf spring has seated. Be sure to attach both leaf springs.

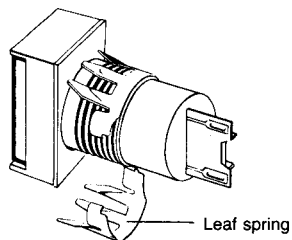

Insert the buzzer assembly into the hole on the mounting panel from the front.

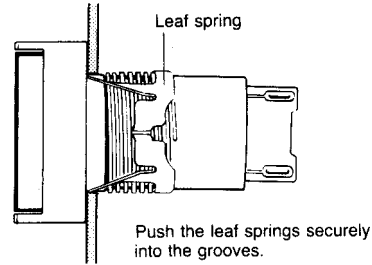

■ SHORT-CIRCUITING JUMPER

The buzzer sounds continuously or intermittently depending on how the short-circuiting bracket is attached to the case guide. When the bracket is attached with the triangle on it facing direction A (PC board side), the buzzer sounds intermittently.

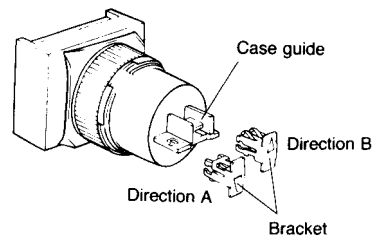

To produce continuous sounds, attach the bracket to the case guide so that the triangle on the bracket faces direction B.

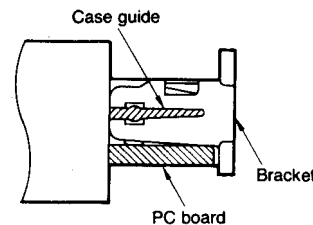

Complete "Terms and Conditions of Sale" for product purchase and use are on Omron's website at www.omron247.com - under the "About Us" tab, in the Legal Matters section.

ALL DIMENSIONS SHOWN ARE IN MILLIMETERS.

To convert millimeters into inches, multiply by 0.03937. To convert grams into ounces, multiply by 0.03527.

OMRON[®]

OMRON ELECTRONICS LLC

1 Commerce Drive
Schaumburg, IL 60173
Tel: 847.843.7900

For U.S. technical support or other
inquiries: 800.556.6766

OMRON CANADA, INC.

885 Milner Avenue
Toronto, Ontario M1B 5V8
Tel: 416.286.6465

MEXICO SALES OFFICES

Mexico, D.F. 555.660.3144
Ciudad Juárez 656.623.7083
Monterrey, N.L. 818.377.4281
Querétaro 442.135.4510

BRAZIL SALES OFFICE

Sao Paulo 55.11.2101.6310

ARGENTINA SALES OFFICE

Cono Sur 54.114.787.1129

CHILE SALES OFFICE

Santiago 562.206.4592

OTHER LATIN AMERICAN SALES

mela@omron.com

OMRON ON-LINE

Global -
www.omron247.com

USA -
www.omron247.com

Canada -
www.omron.ca

Brazil -
www.omron.com.br

Latin America -
mela@omron.com